

The Syntactic Flexibility of French Degree Adverbs

Anne Abeillé and Danièle Godard

Université Paris 7 & LLF, CNRS
abeille, dgodard @linguist.jussieu.fr

Proceedings of the HPSG03 Conference

Michigan State University, East Lansing

Stefan Müller (Editor)

2003

CSLI Publications

<http://csli-publications.stanford.edu/>

Abstract

While French degree words have been assigned several syntactic categories, we show that they are rather highly ‘polymorphic’ adverbs (they occur in all syntactic domains), which select the expression they modify on a purely semantic basis. Like French adverbs in general, they occur both to the left and to the right of the head they modify. Following previous work (a.o. van Noord and Bouma 1994, Abeillé and Godard 1997, Bouma et al. 2000), we assign them two different grammatical functions, adjuncts and complements. Semantically, they differ from quantifiers. We follow Kennedy (2000) who analyzes them as scalar predicate modifiers. Finally, the specific syntactic constraints that characterize a subset of them can be shown to follow from, or be related to, their weight properties (Abeillé and Godard 2000). We conclude that their apparently idiosyncratic properties fit into a more general theory of grammar.

Introduction

Degree words have been analyzed differently, depending on the syntactic domain where they occur. We show that they should simply be analyzed as adverbs. Like adverbs in general, they occur to the left or to the right of the head of the expression they modify; as with adverbs in general, we assign them two grammatical functions: adjuncts and complements. There is no need to make degree words special, either regarding their part of speech or their function.

It is a matter of some debate whether degree words are quantifiers, or predicate modifiers. We consider them to be predicate modifiers, selecting a scalar predicate. Their syntactic polymorphism follows from the fact that they select the expression they modify on a purely semantic basis, and that expressions of different syntactic categories can be scalar.

A subset of degree adverbs shows certain interesting distributional restrictions. These are related to the weight (lightness) properties of some degrees, which also characterize adverbs of other semantic classes. Our hierarchy of weight includes ‘weak’ forms among weight deficient forms, a move which helps explaining why a few adverbs appear to be less polymorphic, appealing to a ‘blocking effect’.

1 The main properties of French degree words

1.1 Degree words are adverbs

Degree words have not always been analyzed as adverbs. In particular, they have been classified as ‘degrees’, ‘Q(uant)’ or ‘determiners’ in the adjectival or nominal domains (e.g. Milner 1973, 1978, Gross 1977, for French; see also Jackendoff 1977, Corver 1997). They are best analyzed as adverbs in all of their occurrences.

- **Syntactic polymorphism**

A striking property of degree words is that they can modify expressions belonging to all syntactic categories as illustrated in (1). This follows if degree adverbs select the expression they modify essentially on a semantic (rather than syntactic) basis (see also Doetjes, 1997).

- (1)
- Paul a **exagérément** apprécié ce film.
Paul has excessively appreciated this film
 - Autant** femme que reine, Marie commettait des erreurs.
As-much queen as woman, Marie was making mistakes
 - Complètement** ivre, il renonça sagement à conduire.
Completely drunk, he wisely gave up driving
 - Très** au courant des dernières découvertes, il gardait bon espoir.
Very up to date about recent scientific progress, he had good hopes
 - Il avait convaincu **beaucoup** de monde.
He had convinced much of people (= a lot of people)
 - Très** gentiment, il a proposé ses services.
Very kindly, he has offered his services

Although degree words are specially flexible, adverbs in a general way are not limited to the verbal domain; examples are given in (2):

- (2)
- evaluatives *bizarrement bleu , curieusement peu*
strangely blue, curiously little.
 - modals *probablement ivre, peut-être depuis Paris*
probably drunk, perhaps from Paris
 - agentives *intelligemment partisan des réformes*
intelligently adept of reforms
 - frequency adv *des collaborateurs souvent ivres, toujours à cheval*
associates often drunk, always on horses
 - negations *des enfants pas peureux, jamais en panne d'idées*
children not fearful, never without ideas
 - frames *globalement positif, légalement en charge de ce dossier*
globally positive, legally in charge of this problem
 - time adv *aussitôt ivre, aujourd'hui président*
immediately drunk, today president
 - manners *sincèrement amoureux/ partisan de*
sincerely in love / in favour of

- **Morphology**

Many degree words display the typical French adverb formation: they are derived from adjectives with the affix *-ment*, cf. (1a,c). Some of them are not so derived: *beaucoup, peu, trop, plus, autant, très*, etc., cf. (1b,d,e,f). However, the presence of the suffix *-ment* on an adjectival base is not necessary to define adverbs (see forms like *soudain* 'sudden(ly)', *souvent* ('often'), *jamais* ('never')).

Moreover, the phenomenon known as 'quantification at a distance' (3b) (Obenauer 1983, Doetjes 1997) indicates that the same adverb occurs in the nominal and verbal domains, since this adverb, which syntactically modifies a verb, must

semantically modify both the participle and the NP. Its occurrence is necessary for the object NP to be allowed, but it semantically selects the participle.

- (3) a. Paul a lu beaucoup de livres sur le sujet.
Paul has read a-lot of books on the topic
b. Paul a *(beaucoup) lu de livres sur le sujet.
P. has a-lot read of books on the topic
c. Paul a aimé beaucoup de films dernièrement.
Paul has loved a-lot of films lately
d. * Paul a (beaucoup) aimé de films dernièrement
Paul has a-lot loved of films lately

• **Degree words in the verbal domain**

In French, there is a clear criterion for defining adverbs: adverbs and only adverbs occur between the tense auxiliary and the past participle with an integrated prosody, as shown by the contrast between the adverb *souvent* and the NP *plusieurs fois*, in (4) (or the similar contrast between the adverb *gentiment* ‘kindly’ and the PP *d'une manière gentille* ‘in a kind way’, Sportiche 1994). See Abeillé et al. (2003), Abeillé and Godard (2003). Crucially, degree words (whatever their morphology) occur in this criterial position.

- (4) a. Paul a **souvent** conduit ses enfants à l'école.
Paul has often driven his children to school
b. *Paul a **plusieurs fois** conduit ses enfants à l'école.
Paul has several times driven his children to school
- (5) Paul a **trop / complètement** lu ce texte.
Paul has too(-much) / completely read this text)

A word of caution is in order here. The distributional contrast illustrated in (4) characterizes expressions with an ‘integrated’ prosody, that is, which are intonationally part of the sentence. Expressions with an ‘incidental’ prosody have different distributional properties (in particular, incidental NPs and PPs can occur between the auxiliary and the participle, Bonami et al. 2002).

Like French adverbs in general, degree words occur to the right of verbs, but not to the right of non-verbal categories (again, incidental adverbs may behave differently):¹

- (6) a. Jean téléphone beaucoup / excessivement / davantage à son frère.
Jean calls much / excessively / more to his brother
b. Excessivement inquiet, Paul se rongait les ongles.
Excessively worried, Paul was eating his nails
b'. ?? Inquiet excessivement, Paul se rongait les ongles.
c. Complètement femme, elle se réfugiait dans le sourire.
Completely woman, she took refuge in the smile
c'. * Femme complètement, elle se réfugiait dans le sourire.

¹ This is not true for (non-light) comparative adverbs, see examples (14c,d).

- (7) a. Toujours maire de son village, Jean était très occupé.
 Still mayor of his village, Jean was very busy
 a'. *Maire toujours de son village, Jean était très occupé.
 b. Evidemment/ Probablement séduisante, cette actrice ...
 Evidently / Probably attractive, this actress ...
 b'. ?? Séduisante évidemment/ probablement, cette actrice ...

While adverbs occur to the left of non-verbal and non-finite verbal categories, they do not occur to the left of finite ones in French (unless they are incidentals; we note incidentality by commas), see Bonami et al. (2002). Again, degree words (which cannot be incidentals) behave like adverbs in general.

- (8) a. Jean viendra probablement.
 Jean will-come probably
 b. Probablement *(,) Jean viendra.
 Probably, Jean will-come
 c. Jean *(,) probablement *(,) viendra.
 d. Jean aime beaucoup ce livre.
 Jean likes much this book
 e. * Beaucoup Jean aime ce livre.
 Much Jean likes this book
 f. * Jean beaucoup aime ce livre.

On the basis of this array of properties, we can safely conclude that degree words are adverbs.

1.2 The semantics of degree words

The semantics of degree words is a matter of debate. The question is whether they are *bona fide* quantifiers (with a domain of quantification, and a scope), or predicate modifiers. We follow Kennedy (2000), who argues that degree words should be treated differently from quantifiers.¹ In Kennedy's terms, degrees modify a predicate associated with a scale, with a contextually fixed value on the scale, and change this value.² Given that *beaucoup*, when it modifies a count event predicate, has an interpretation similar to that of the quantifier *souvent* (9), we follow Doetjes (1997) in comparing the two adverbs in their ad-verbial usage. The first set of arguments, which is line with Kennedy's approach, concerns scope properties. While *souvent* and a negation such as *aucun N* ('no N') exhibit scope ambiguities, this is not the case for *beaucoup*. In (9c), the interpretation where the adverb would have scope over the negation is absent.

¹ For a defense of the degree as quantifier approach, based on degrees of comparison, see Stateva (2002).

² Doetjes (1997)'s idea is similar (in her terms, degrees saturate an open quantity or grade position in another phrase). However, she assumes that they are a special case of quantifiers ('degree quantifiers').

- (9) a. Elle va souvent / beaucoup au cinéma.
She goes often / a-lot to the movies
b. Elle ne voit souvent aucun étudiant.
She ne-sees often no student
'There is no student that she sees often'
'It is often that she does not see any student'
c. Elle ne voit beaucoup aucun étudiant.
She ne-sees no student
'There is no student that she sees a-lot'

Moreover, *beaucoup*, unlike *souvent*, always has lower scope than a scopal adverb. Given that a scopal adverb has scope over an adverb which follows it (see section 3.2), the impossibility of the order *beaucoup* + *longtemps* indicates that the degree adverb must be in the scope of the duration adverb.¹

- (10) a. Elle est souvent partie longtemps.
She is often gone long-time (she often went away for a long time)
b. Elle est longtemps partie souvent.
She is long-time gone often (for a long time she often went away)
c. * Elle est beaucoup partie longtemps.
d. Elle est longtemps beaucoup partie.

The fact that an expression exhibits scope ambiguities with scopal expressions may not be sufficient to indicate that it is a quantifier.² But the fact that it fails to exhibit ambiguities argues against its being a quantifier, specially in view of the contrast between *souvent* and *beaucoup*.

Doetjes (1997) gives a second set of arguments, showing that degrees cannot introduce their quantification domain, unlike a quantifier such as *souvent*. For instance, unlike *souvent*, *beaucoup* cannot impose iteration of the event. This is clear with a non-count predicate such as *pleuvoir*: while (11a) says that it rained lots of times, (10b) can only measure the amount of rain, without indicating whether it rained often, or once or twice but abundantly.

- (11) a. Il a souvent plu ce mois-ci.
It rained often this month
b. Il a beaucoup plu ce mois-ci.
It rained a-lot (= abundantly) this month

¹ *Beaucoup* can follow or precede a non scopal adverb such as a frame adverb (*professionnellement*):
(i) Ce livre me sert beaucoup professionnellement / professionnellement beaucoup. (this book helps me a lot job-wise)

² An NP including a degree word may exhibit scope ambiguities, as does the partitive construction in (i). However, a comparable ambiguity seems to exist with the definite NP, a fact which casts doubt on the explanation of the scope properties in terms of quantification in this case:

- (i) Paul a souvent lu beaucoup de ces livres. (P. has often read a-lot of these books)
'There are many of these books which P. has read often'
'There are many periods of time during which P. read a-lot of these books'
(ii) Paul a souvent lu ces livres. (P. has often read these books)
'These books, P. has often read'
'There are many periods during which P. has read these books'

Souvent, being a quantifier, introduces a domain of quantification, that is, a set of situations (which can be implicit, as in (11)), and quantifies by comparing this set with that associated with the rest of the sentence, see e.g. de Swart (1991). On the other hand, *beaucoup* does not do that: it must find a scale in the predicate which it modifies. Since the predicate ‘to rain’ is not countable, the scale cannot be defined in terms of number. We conclude that a degree adverb such as *beaucoup* does not behave like a quantifier.

Following Kennedy (2000), Kennedy and McNally (2000), we consider that degrees modify a value on a scale associated with a predicate. The scale is defined in terms of natural numbers as well as intensity, so that, as a class, they can modify count and mass predicates. The scale can be either closed (with a maximum value) or open (no maximum value). We distinguish three (main) subtypes of degree adverbs, depending on the scale type (Abeillé et al. 2003): (i) completion adverbs (they require a closed scale): *complètement, partiellement, etc.*; (ii) intensity adverbs (they require an open, intensity scale): *intensément, infiniment, etc.*; (iii) ‘pure’ degree adverbs (they underspecify the kind of scale they modify, intensity or quantity, Doetjes 1997): *trop, plus, beaucoup, énormément, etc.*

(12) scale types

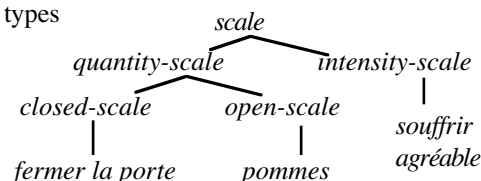

The compatibility between degree classes and the scale type is illustrated in (13):

- | | | | |
|------|-----|--------------------------------------|---|
| (13) | a. | Il a partiellement traduit le texte. | He has is partially translated the text |
| | a'. | ?? Il a souffert partiellement. | He has partially suffered |
| | b. | Il a souffert intensément. | He has suffered intensely |
| | b'. | * Il part intensément en voyage. | He goes away intensely |
| | c. | Il part beaucoup en voyage. | He goes away a-lot |
| | c'. | Il a souffert beaucoup. | He has suffered a-lot |

In (13b, c'), *intensément, beaucoup* modify a predicate with an open intensity scale. In (13a), *partiellement* modifies a predicate (*traduire le texte*) with a closed scale; this telic predicate denotes an event which can be divided into sub-events, which together form a scale of quantity. Since *partiellement* selects a predicate with a closed scale, it cannot modify a verb like *souffrir*. Since *intensément* selects a predicate with an intensity scale, it cannot modify a count predicate like *partir en voyage*. The only scale that can be associated with such a predicate is the number of occurrences of the event, that is a (open) quantity scale. Since *beaucoup* does not specify the scale type, it can modify *souffrir* as well as *partir en voyage*.

2 Degree adverbs as adjuncts

We propose that degree adverbs to the left of the expression they modify can be systematically analyzed as adjuncts. They have been considered as specifiers of A or N in e.g. Milner (1978), for French, Jackendoff (1977), Pollard and Sag (1994), Ginzburg and Sag (2000), for English; they have also been considered as heads of a functional projection, taking the AP as a complement (Corver 97); Doetjes (1997, 2001) divides them between functional heads and adjuncts; finally, they could be analyzed as specifiers of an abstract functional projection in the verbal domain, in the general approach to adverbs found specially in Cinque (1999). The functional projection approach to adverbs is criticized in Abeillé and Godard (2003) (see also Ernst 2002); we leave aside the question of such abstract projections, stressing some problems for the specifier analysis with the usual categories (N, A, V). After explaining our analysis, we turn to constraints on adjunction characterizing certain subsets of degree adverbs.

2.1 Degree adverbs are not specifiers

We note first that the specifier analysis of degree adverbs presents no advantage over our approach which attributes them two different grammatical functions, since it cannot cover all the cases. Specifiers occur to the left of the head in French. However, as illustrated above, degree adverbs can occur to the right of the infinitival V (14b'), and must occur to the right of the finite V (14a'). Accordingly, they cannot be considered specifiers of V. It would not be sufficient to say that, exceptionally, the verb can or must 'move' to the left of its specifier, since degree adverbs can scramble with complements (14b''): movement of complements must be added to V movement. Furthermore, degree adverbs can also occur to the right of N and A in some specific cases: comparative degree adverbs (if 'non-light', see section 2.3 on weight) can occur to the right of predicative N and A.

- (14) a. *Paul beaucoup téléphone à son frère.
Paul a-lot calls his brother
a'. Paul téléphone beaucoup à son frère
b. % Il craignait de complètement perdre la tête.
He was-afraid of completely los(ing) his mind
b'. Il craignait de perdre complètement la tête.
b''. craignait de perdre la tête complètement.
c. Présent davantage, il aurait été au courant.
Present more (often), he would have known better
d. Femme plus que reine, elle ne plaisait pas à la cour.
Woman more than queen, she did not like court life

The specifier analysis is problematic with verbs, even when they occur to the left. Specifiers are expected to occur at the highest structural level, and, hence, to have wide scope over a coordination of heads. This is not what we find with non-*-ment* derived ‘pure’ degree adverbs, which can only have wide scope over a coordination of lexical V_s, not over a coordination of VPs:

- (15) a. * On lui reprochait de trop lire de BD et regarder de feuilletons.
 They faulted him of too(-much) read of comics and watch of soap operas
 ‘They criticized him for reading to many comic books and watching too many soap operas’
 b. On lui reprochait de trop lire et regarder de bandes dessinées.
 They faulted him of too-much read and watch of comics

The contrast in (15) shows that the degree adverb *trop* cannot have wide scope over the conjunction in (15a); if it did, it would allow the second object of the form ‘de N’. In order to account for these data, one would have to say that pure degree adverbs are specifiers of V, not of VP, a move which does not square well with usual X-bar theory. A simpler line of analysis is to follow that developed for some manner adverbs in French (cf. *bien, mal, mieux...*), namely to analyze pure degree adverbs as adjoined to V° (Abeillé and Godard 1997, 2001).

With non-predicative Ns, the degree adverb is followed by ‘de’ (*beaucoup *(de) chance / beaucoup *(de) problèmes*, a-lot of chance / a-lot of problems). This is unusual for specifiers which normally precede the N without ‘de’ (*trois / certains / les livres*, ‘three / some / the books’). The first possibility is that the two forms constitute a complex specifier. However, this option is not available, since the ‘de Ns’ can be conjoined:

- (16) a. beaucoup de pain et de vin
 a-lot of bread and of wine
 b. beaucoup de collaborateurs étrangers et de visiteurs
 a-lot of collaborators foreign and of visitors

Alternatively, the adverb could function as the specifier of the ‘de N’ constituent. The problem is that such a constituent can occur independently, without a specifier, as in negative contexts (17). Analyzing the adverb as a specifier in the nominal domain thus implies either that French N can occur without a specifier or that NPs can have several specifiers. The first option goes against the well-known fact that French lacks the ‘bare noun’ construction, the possibility for N to lack a determiner being extremely constrained and limited in a general way to predicative N (such as the adjunct N in (14e), or the object of a light verb in *rendre hommage* ‘pay tribute’, for instance). The second option goes against the usual assumptions of the X-bar theory, on which the specifier analysis is based.

- (17) a. Personne n'a pris de pommes / de pain.
 Nobody took of apples / of bread (nobody took any apples/ any bread)

- b. Je ne pense pas qu'on ait acheté de journal aujourd'hui.
I don't think that we bought of newspaper today

Since the analysis does not work for the verbal domain, and encounters problems even in the NP domain, where its justification would seem at first to be the least problematic, we conclude that degree adverbs should not be analyzed as specifiers.

2.2 Degree adverbs as adjuncts

The analysis of degree adverbs as adjuncts is straightforward. Polymorphism follows from the fact that degree adverbs do not specify the syntactic category of the head they adjoin to. We use the usual head-adjunct construction, which, enriched with (some) semantic features, is given in (19).¹ This construction allows the structures in (18) with degree adverbs, for instance, which illustrate some of the analyses discussed in the paper (for the adjunction of the adverb to a 'de NP', see Miller 1992, Doetjes 1997):

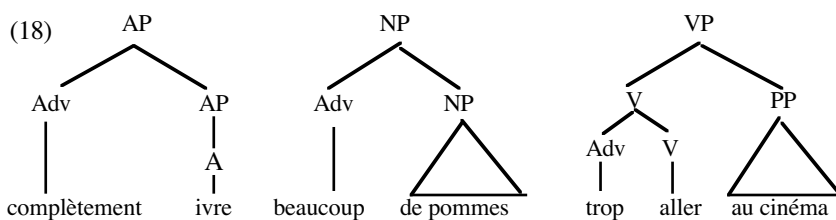

(19) *head-adjunct-construction* ⇒

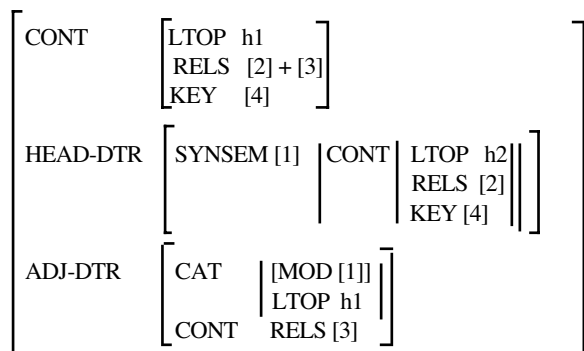

Adjunct degree adverbs obey two general constraints, which take the distinction between prosodically integrated and incidental expressions into account. The first (20a) says that only incidental expressions can adjoin to finite verbs. This accounts, in particular, for the data in (8), (14a).² The second (20b) orders non incidental

¹ We follow Sag et al. (2003) in distinguishing between constructions (or rules of grammar), which have daughters, and phrases (or words) which do not.

² As mentioned above, incidental ([INCID +]) adverbs have different distributional properties.

adverbs before the head they modify. It follows from (20b) that adverbs to the right of the head are not adjuncts.

(20) Two constraints on adjunction

- a. $\left[\begin{array}{l} \textit{head-adjunct-construction} \\ \text{HEAD-DTR} \text{IHEAD} [\textit{V finite}] \end{array} \right] \Rightarrow [\text{ADJ-DTR} \quad [\text{INCID +}]]$
- b. $\textit{head-adjunct-construction} \Rightarrow \text{ADJ-DTR} \left[\begin{array}{l} \textit{adverb} \\ \text{INCID -} \end{array} \right] \mathbf{precedes} \text{HEAD-DTR}$

A partial semantic description of the head-adjunction construction is given in (19), in a Minimal Recursion Semantics approach (Copestake et al. 2003). Relations from the daughters are added (they form a (multi-)set on the mother node); the KEY relation is that of the head daughter, but the semantic head of the construction is the adjunct daughter (Pollard and Sag 1994): the LTOP value of the construction is identified with that of the adjunct daughter. From this and the ordering constraint (20b), it follows that an adjunct adverb can only occur to the left of another adverb if it has scope over it.

Degree adverbs (partially) specify the semantics of the head they adjoin to. Although not all degree adverbs can modify ‘de NPs’, no syntactic constraint has to be added: completion adverbs cannot modify ‘de NPs’ because ‘de NPs’ are associated with an open scale (**complètement de pommes / d'argent*, completely of apples / money), and intensity adverbs cannot modify plural ‘de NPs’, because plural ‘de NPs’ are associated with a quantity scale (*infiniment de peine vs *infiniment de pommes*, infinitely of grief / apples).

We assume that the following are scalar predicates: plural and mass N, gradable adjectives and adverbs, psychological predicates and non count verbal predicates more generally, predicates denoting an event decomposable into parts, and iterated count event predicates, see Doetjes (1997), Kennedy (2000), Kennedy and McNally (1999). We represent scalar predicates as having a scale type with a SCALE VALUE attribute. We exemplify with a completion adverb. The entry for ‘pure’ degree adverb (e.g. *peu, trop*) is similar, except that it says nothing about the type of the scale (see (28)). We exemplify the composition of a pure degree adverb and a gradable adjective.

(21) *complètement* :

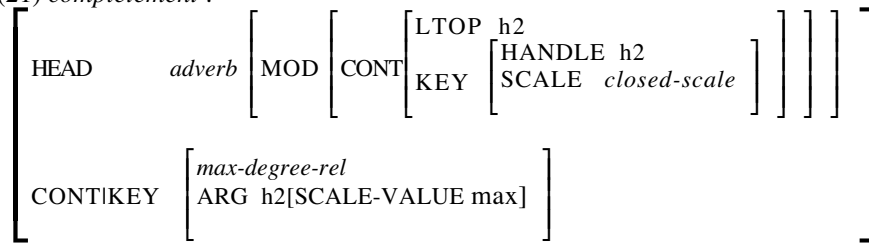

(22)

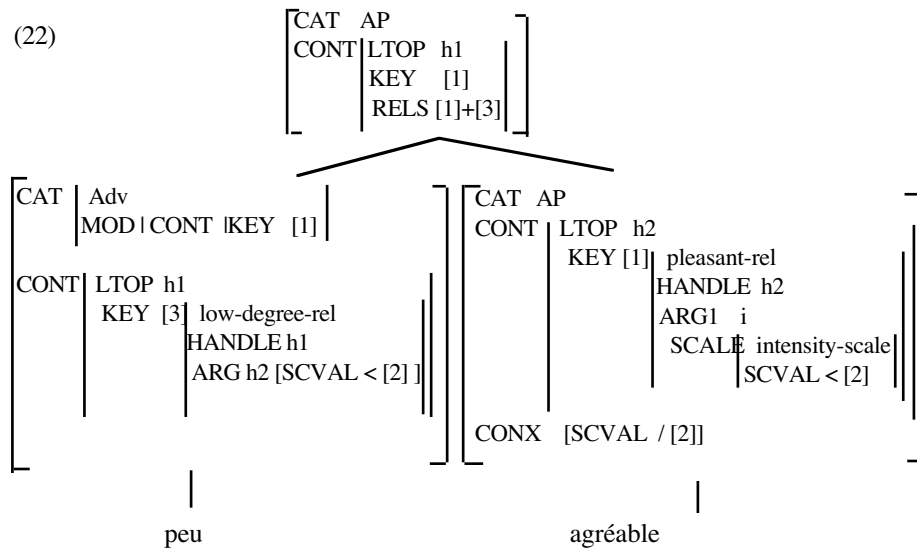

2.3 Light degree adverbs

We turn to constraints on adjunction which are related to weight, a syntactic feature appropriate for words and phrases, understood as in Abeillé and Godard (e.g. 2000). Here, we extend the hierarchy of weight types to include weak elements:¹

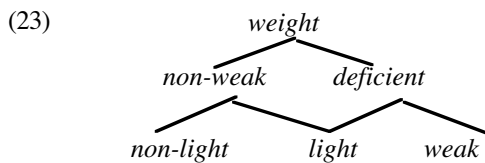

Weight deficient elements have the following characteristic properties: (a) they cannot be extracted; (b) they occur before non-light complements (except for adverbs) in the head-complements-phrase (see section 3.3). Contrary to light forms, weak forms cannot be modified or conjoined, nor occur in isolation (Cardinaletti and Starke 1994). They are necessarily words. Light forms can be conjoined or modified:

¹ We substitute the usual ‘light’ for ‘lite’ used in e.g. Abeillé and Godard (2000).

light constructions are coordinations or modifications, made of light elements. We have the following constraints:

(24) Weight and constructions

- a. *construction* => [WEIGHT *non-weak*]
- b. *construction* [MOTHER *light*] => [DTRS list ([WEIGHT *deficient*)]
- c. *head-complements-construction* =>
MOTHER [WEIGHT *non-light*], HEAD-DTR [WEIGHT *deficient*]
- d. *head-adjunct-construction* or *coord-construction* =>
HEAD-DTR [WEIGHT *non-weak*]

Some degree adverbs, the ‘beaucoup class’, adjoin to the lexical V, but not to the (non-light) VP (see (15), (18)). Actually, they adjoin to a light (rather than lexical) V, since they can adjoin to a conjunction of lexical Vs (see (15b)). They are pure degree adverbs and light (see section (41)). This constraint on adjunction is related to their weight, not to their semantic sub-class: a few manner adverbs (*bien, mal*) behave identically (Abeillé and Godard 2000, 2001), and a few pure degree *-ment* degree adverbs (*énormément, excessivement, suffisamment*), as well as completion (*complètement*) and intensity (*profondément*) adverbs behave differently. Derived *-ment* adverbs are non-light, can have wide scope over a conjunction of VPs (at least for some speakers, hence the ‘%’ notation), and adjoin to VPinf.

- (25)
- a. % Il craignait de ne pas suffisamment plaire à une compagne ni aimer les enfants pour se lancer dans le mariage.
He was afraid not to sufficiently please a companion nor love children to dare getting married
 - b. % Il craignait de complètement perdre la tête et rater ses examens.
He was afraid of completely lose his mind and fail his exams
 - c. % Il avait réussi à profondément choquer les spectateurs et impressionner ses collègues.
He had succeeded in profoundly shock(ing) the audience and impress(ing) his colleagues

However, even adverbs of the ‘beaucoup class’ adjoin to non-light non-verbal categories. Thus, they are adjoined to a non-light NP, Adv, and AP in (26,a,b,c):

- (26)
- a. trop [de pommes] / trop [en colère] (too of apples / too in rage)
 - b. plus gentiment, plus probablement (more kindly, more probably)
 - c. ? quelqu'un de plus intéressé par le job et capable de dévouement
somebody of more interested in the job and capable of devotion

Moreover, a non-light degree adverb can adjoin to a light head, as we can see with attributive adjectives. The relative order of adjectives and nouns in French depends on several factors; one of them is weight: adjectives to the left of the N are light, adjectives to the right of the N are non-light (Abeillé and Godard 2000). For

instance, no adjectives can precede the N if they have complements (27a, a'), or if they are modified by a *-ment* (non-light) adverb (27b, b'). On the other hand, an adjective modified by a light degree adverb can occur both prenominally and postnominally (27c).

- (27) a. une facile victoire / une victoire facile
 an easy victory / a victory easy
 a'. *une facile pour vous victoire / une victoire facile pour vous
 an easy for you victory / a victory easy for you
 b. ?? Une [suffisamment / excessivement grande]_{AP} difficulté
 a sufficiently / excessively big difficulty
 b'. Une difficulté [suffisamment / excessivement grande]_{AP}
 c. un [très bon]_{AP} résultat / un résultat [très bon]_{AP}
 a very good result

All these data follow from our hypotheses regarding weight: a head-complements-construction is non-light, a head-adjunct-construction with a non-light daughter is non-light, and a head-adjunct-construction with two light daughters can function either as a light or non-light phrase. Accordingly, French does not support a general weight constraint such that adjuncts and heads should have the same weight (contrary to the constraint proposed for English in Sadler and Arnold 1994). The constraint illustrated in (15) is lexically specified, characterizing a class of light degree and manner adverbs, which adjoin to light Vs, but do not specify the weight of the other categories. Thus, the weight specifications for *trop* are as in (28):

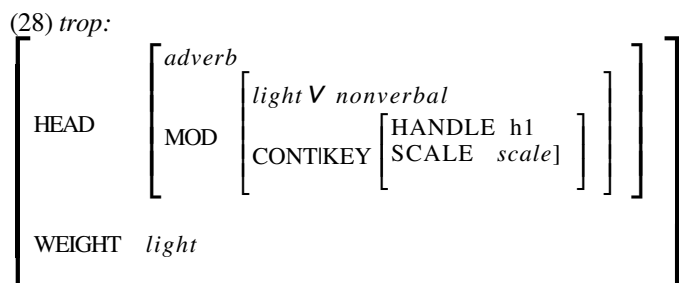

In addition to this lexical constraint, weight is also relevant for the ordering of the daughters of the head-adjunct construction. Adjoined degree adverbs follow more general constraints:

- (29) Ordering constraints on the head-adjunct-construction:
 a. HEAD-DTR [*noun*] **precedes** ADJ-DTR [*non-light*]
 b. ADJ-DTR [*light*] **precedes** HEAD-DTR
 c. ADJ-DTR [*adverb*] **precedes** HEAD-DTR

2.4 Weak degree adverbs: the *beaucoup/ très* alternation

A few pure degree adverbs (*beaucoup* ‘a-lot, much’, *tant* ‘so-much’, *autant* ‘as-much’) can only adjoin to verbs and ‘de NP’, which seems to threaten the generalization that degree adverbs do not syntactically specify the modified category. In fact, they are in complementary distribution with the corresponding adverbs *très*, *si*, *aussi*, which only adjoin to non-verbal predicative categories (Gatone 1981).

- (30) a. Paul a [très/ si peur]NP (has very / so fear)
 b. Paul est très gentil / en colère. (very kind / very-much in a rage)
 c. Paul est si gentil / en colère. (so kind/ so-much in a rage)
 d. * Il ne faut pas * très / si manger ! (one does not very/ so eat)
 e. * très de pommes / de chance (a-lot of apples / of chance)
- (31) a. * Paul est beaucoup gentil / en colère. (a-lot kind/ in a rage)
 b. * Paul est tant gentil/ en colère. (so kind/ so-much in a rage)
 c. Il ne faut pas beaucoup / tant manger. (one does not a-lot/ so-much eat)
 d. beaucoup de pommes / de chance (a-lot of apples / of chance)

We follow Doetjes (2001) in analyzing this distribution as a blocking effect: where the more constrained forms can occur, the less constrained forms are not available. Following Abeillé et al. (2003), we propose that *très /si /aussi* are weak forms: they cannot be modified, conjoined or occur in isolation (32); the others are light, not weak. As explained in section 2.3, we consider weak to be one possible value for the feature WEIGHT. Given (33), the lexical entry for *très* is as in (34).

- (32) a. Paul est-il fort ? – * Vraiment très. (Is Paul strong? – really much)
 b. ?? un homme très ou trop fort (a man very or too strong)

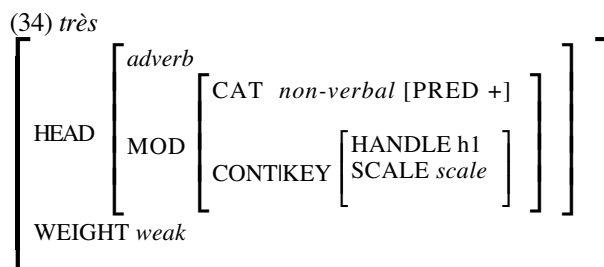
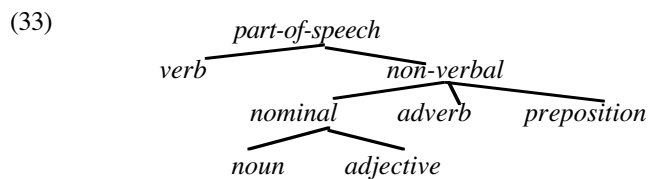

3 Degree adverbs as complements

3.1 The analysis

Following van Noord and Bouma (1994), Abeillé and Godard (1997), Bouma et al. (2000) a.o., we analyze degree adverbs as complements when they occur to the right of the modified category. This provides a straightforward account of the fact that adverbs (unless they take a propositional argument, e.g. Abeillé and Godard 2003) can scramble with non adverbial complements ((14b',b'') and (35a,a')), given that complements scramble in French (35b,b'). It also accounts for that fact that they can be clefted (35c):

- (35) a. Jean a complètement raté son examen.
a'. Jean a raté complètement son examen.
Jean failed his exam completely
b. Jean donnera une pomme à chacun.
b'. Jean donnera à chacun une pomme.
Jean will give an apple to each of them
c. C'est profondément qu'il a choqué les spectateurs.
It is deeply that he shocked the audience

Some degree adverbs are lexically subcategorized complements (36), while most are added to the dependent list of the verb following a lexical construction:¹

- (36) a. Paul mange sa soupe / mange beaucoup. (Paul eats his soup / a lot)
a'. * Paul mange beaucoup sa soupe (Paul eats a lot his soup)
b. Ça coûte plus / davantage (it costs / is worth more)
b'. * Ça coûte / vaut. (it costs / it is worth)

To get postverbal adverbs as complements of the V, we use a 'lexical construction', given in (37). A lexical construction has the advantage over a lexical rule not to create a potentially infinite lexicon. The lexical construction implies checking 'on the fly' that the argument list of the V is extended to include adverbs, and does this each adverb at a time. An adverb can be taken as an argument if its MOD value concerning the HEAD and KEY features match those of the V. Accordingly, selectional restrictions are taken into account; for degree adverbs, this takes care of the requirement that the key relation be scalar. Each adverb takes the verb (which may be already an extended verb, the semantic argument of the adverb being the verb's LTOP value rather than its KEY's value) as its semantic argument,² and the new LTOP of the extended verb is that of the adverb. This ensures that the adverb has scope over the content of the verb and other complement

¹ The first element of the dependent list is the subject, the others are complements.

² With degree adverbs, the LTOP of the verb is identical to the KEY's handle, see (21).

(39) Ordering constraints on head-complements-construction

- a. *head-complements-construction* => HEAD-DTR **precedes** COMP-DTRS
- b. *head-complements-construction* => [*adverb*] **oblique-precedes** [*adverb*]

An example involving two adverbs in a VP (cf. (38a)) is given in (40):

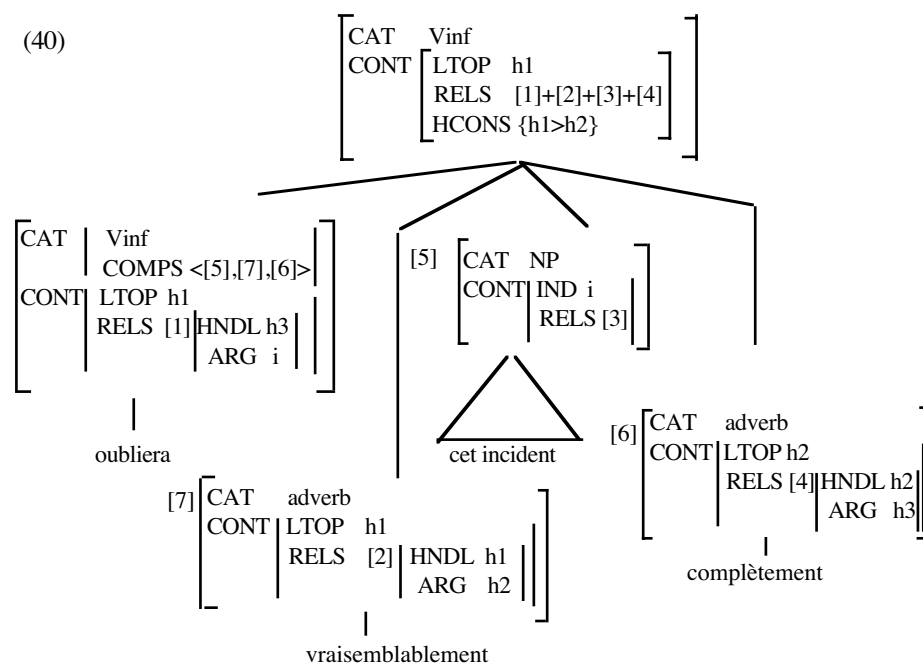

3.3 Light complement adverbs

The lightness constraint on ordering applies to complements in general. Adverbs such as *pas*, *plus*, *bien*, *mal*, *trop*, *beaucoup* are light, while adverbs such as *aucunement*, *correctement*, *abondamment* are non-light. Note that light adverbs belong to different semantic classes: negations, manner and degree adverbs. Light adverbs do not scramble with other complements (Blinkenberg, 1928), unless they are modified or stressed, and cannot be extracted (see section 2.3).

- (41) a. *Marie traite son frère bien.
Mary treats her brother well
- b. Marie traite son frère [vraiment très bien].
Marie treats her brother really very well
- c. *Marie voit son frère trop.
Marie sees her brother too much
- d. Marie voit son frère [trop ou trop peu], suivant les moments.
Marie sees her brother too much or too little, depending on circumstances

On the other hand, non-light adverbs can occur before light adverbs or nouns etc., as seen in (42), where the non-light *vraisemblablement* precedes the light Adv *bien* and the light N *raison*. This shows that light complements (adverbs or nouns) are not incorporated into the V.

- (42) a. Marie voit vraisemblablement trop son frère.
 Marie sees probably too(-much) her brother
 b. Marie a vraisemblablement raison.
 Marie has probably reason (= is probably right)

Constraint (43) covers the different effects of the weight distinction among complements. It allows non-light adverbs (which are [ADV+]) to precede light advs or Ns, while forcing the latter to precede non-light, non adverbial ones (NP or PP).

- (43) *head-complements-phrase* => [light] precedes [non-light [ADV -]]

Constraint (43) is illustrated in (44) (*voit beaucoup son frère*, sees a-lot his brother, *mange bien sa soupe*, eats well his soup). On the other hand, since no constraints are specified for non-light complements and adverbs, they are free to scramble among themselves, as illustrated in (45) (*ferme la porte complètement*, closes the door completely, *mange sa soupe correctement*, eats his soup correctly).

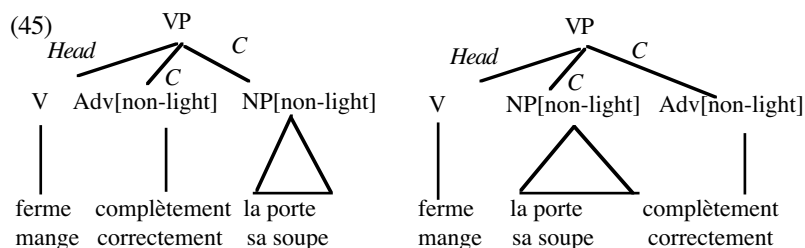
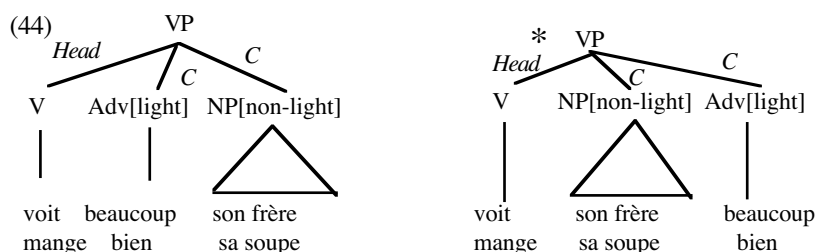

Conclusion

French degree words are interesting syntactically because of their extreme polymorphism (they modify any category) and certain distributional constraints on a

sub-set of them. We show that their syntactic properties follow if they are analyzed as adverbs, which, like French adverbs in general, have two possible functions: adjuncts or complements. Like other adjuncts and complements, they can be further constrained depending on their syntactic weight. In order to account for their polymorphism, we propose that they select the element they modify on a purely semantic basis: they modify scalar predicates and change the standard value associated with that scale. Most of their idiosyncratic properties are thus reconciled with a general theory of grammar.

References

- Abeillé, A., and D. Godard. 1997. The Syntax of French Negative Adverbs, in D. Forget et al. (eds) *Negation and Polarity, syntax and semantics*, 1-27. Amsterdam: John Benjamins.
- Abeillé, A. and D. Godard. 2000. French word order and lexical weight, in R. Borsley (ed) *The Nature and Function of syntactic categories, Syntax and semantics*, 325-360. New York: Academic Press.
- Abeillé, A. and D. Godard, 2001. A class of lite adverbs in French, in J. Camps, C. Wiltshire (eds) *Romance syntax, semantics and their L2 acquisition*, 9-25. Amsterdam: J. Benjamins.
- Abeillé, A. and D. Godard, 2003. French adverbs without functional projections, in M. Coene and A. d'Hulst (eds) *Comparative Romance Linguistics*, Amsterdam: J. Benjamins. (to appear)
- Abeillé, A., J. Doetjes, A. Molendijk, and H. de Swart. 2003. Adverbs and Quantification, in F. Corblin and H. de Swart (eds) *Handbook of French semantics*, Stanford: CSLI (to appear).
- Blinkenberg, A. 1928. *L'ordre des mots en français moderne*, Kopenhagen: Bianco Lunos Bogtrykkeri, *Historik-filologiske Meddelelser XVII:1 et XX:1*.
- Bonami, O., D. Godard and B. Kampers-Manhe. 2002. Adverb Classification, in F. Corblin and H. de Swart (eds) *Handbook of French semantics*, Stanford: CSLI (to appear).
- Bouma, G., R. Malouf, and I. A. Sag. 2000. Satisfying constraints on extraction and adjunction, *Natural Language and Linguistic Theory* 19: 1-65.
- Cardinaletti, A. and M. Starke. 1999. "The Typology of Structural Deficiency: on the three grammatical classes", in H. Riemsdijk (ed) *Clitics in the Languages of Europe*, Berlin: Mouton de Gruyter.
- Cinque, G. 1999. *Adverbs and Functional Heads, a cross-linguistic perspective*, Oxford: Oxford UP.
- Copestake A., D. Flickinger, I. A. Sag, and C. Pollard. 2003. *Minimal recursion semantics: an introduction*, MS, Stanford University.
- Corver, N. 1997. The Internal syntax of the Dutch extended adjectival projection, *Natural Language and Linguistic theory*, 15, 289-368.

- Doetjes, J. 1997. Quantifiers and selection. On the distribution of quantifying expressions in French, Dutch and English, The Hague: Holland Academic Graphics (HIL dissertation series).
- Doetjes, J. 2001. *Beaucoup* est Ailleurs. Expressions de degré et sous-spécification catégorielle, in R. Bok-Bennema, B. de Jonge, B. Kampers-Manhe & A. Molendijk (eds.) *Adverbial Modification*, Amsterdam: Rodopi.
- Ernst, T. 2002. *The Syntax of adjuncts*. Cambridge: Cambridge University Press.
- Gaetone, D. 1981. Observations sur l'opposition *très-beaucoup*, *Revue de Linguistique Romane* 45. 74-95.
- Ginzburg, J. and I.A. Sag. 2000. *Interrogative Investigations; the form, meaning and use of English interrogatives*, Stanford: CSLI.
- Gross, M. 1977. *Grammaire transformationnelle du français : syntaxe du nom*, Paris: Larousse.
- Jackendoff, R. 1977. *X-bar Syntax: a study of phrase structure*, Cambridge, Mass: MIT Press.
- Kennedy, C. 2000. *Projecting the adjective: the syntax and semantics of gradability and comparison*, New York: Garland.
- Kennedy, C. and L. McNally. 1999. From event structure to scale structure: degree modification in deverbal adjectives. in T. Mathews and D. Strolovitsc (eds), *SALT 9*, 163-180. Ithaca: CLC Publications.
- Miller, P. 1992. *Clitics and Constituents in Phrase Structure Grammar*, New York: Garland.
- Milner, J-C. 1973. *Arguments linguistiques*, Paris-Tours: Mame.
- Milner, J-C. 1978. *De la Syntaxe à l'interprétation*, Paris: Le Seuil.
- Obenauer, H. 1983. Une quantification non canonique : la "quantification à distance", *Langue française* 48, 66-88.
- Pollard, C., I.A. Sag, 1994. *Head Driven phrase Structure Grammar*, Stanford: CSLI and Chicago: The University of Chicago Press.
- Sadler, L. and D. Arnold. 1994. Prenominal Adjectives and the phrasal/lexical Distinction, *Journal of Linguistics* 30,187-226.
- Sag, I.A., T. Wasow and E. Bender. 2003. *Syntactic Theory, a Formal Introduction*, Stanford: CSLI.
- Sportiche, D. 1994. *Adjuncts and adjunction*, *GLOW Newsletter* 32, 54-55.
- Stateva, P. 2002. *How different are degree constructions?* PhD dissertation, U. of Connecticut.
- de Swart, H. 1991. *Adverbs of quantification: A Generalized Quantifier approach*, PhD dissertation, University of Groningen.
- van Noord, G. and G. Bouma. 1994. *Adjuncts and the processing of lexical rules*, *Proceedings of COLING 15*, 250-256, Tokyo.